

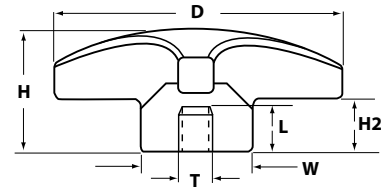

**3 Lobe Knob  
Socket - Phenolic**

These best selling, economical phenolic 3 lobe female threaded (socket) knobs are offered with a brass threaded insert. They have highly polished smooth surfaces and do not show a parting line. Very sturdy and attractive for any industrial or commercial application.



**3 LOBE KNOB SOCKET - PHENOLIC**

P/N	Dia.	Height	Width	H2	Thread	Length
IL260-4F	1	13/16	9/16	3/8	1/4-20	1/2
IL260-5F	1	13/16	9/16	3/8	5/16-18	1/2
IL260-6F	1	13/16	9/16	3/8	3/8-16	1/2
IL261-4F	1-1/2	1	7/8	1/2	1/4-20	1/2
IL261-5F	1-1/2	1	7/8	1/2	5/16-18	1/2
IL261-6F	1-1/2	1	7/8	1/2	3/8-16	1/2

**3 Lobe Knob  
Thru Hole - Phenolic**

These best selling, economical phenolic 3 lobe thru-hole threaded knobs are offered with a brass threaded insert. They have highly polished smooth surfaces and do not show a parting line. Very sturdy and attractive for any industrial or commercial application.

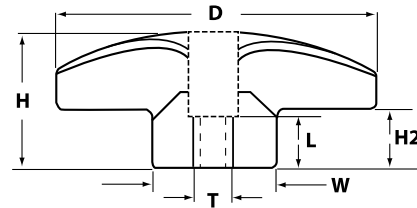

**3 LOBE THRU HOLE KNOB - PHENOLIC**

P/N	Dia.	Height	Width	H2	Thread	Length
IL261-4T	1-1/2	1	7/8	1/2	1/4-20	3/4
IL261-5T	1-1/2	1	7/8	1/2	5/16-18	3/4
IL261-6T	1-1/2	1	7/8	1/2	3/8-16	3/4

**3 Lobe Knob  
Steel Stud - Phenolic**

These best selling, economical phenolic 3 lobe threaded stud knobs are offered with a trivalent zinc plated steel stud. They have highly polished smooth surfaces and do not show a parting line. Very sturdy and attractive for any industrial or commercial application.

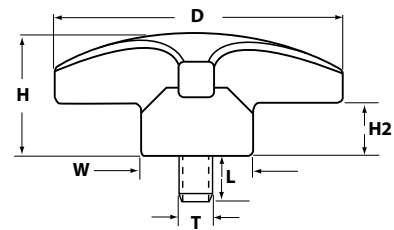

**3 LOBE KNOB WITH STEEL STUD - PHENOLIC**

P/N	Dia.	Height	Width	H2	Thread	Length
IL261-4MX1/2	1-1/2	1	7/8	1/2	1/4-20	1/2
IL261-4MX1	1-1/2	1	7/8	1/2	1/4-20	1
IL261-5MX1/2	1-1/2	1	7/8	1/2	5/16-18	1/2
IL261-5MX1	1-1/2	1	7/8	1/2	5/16-18	1
IL261-6MX3/4	1-1/2	1	7/8	1/2	3/8-16	3/4
IL261-6MX1	1-1/2	1	7/8	1/2	3/8-16	1



**4 Lobe Knob  
Socket - Phenolic**

These best selling, economical phenolic 4 lobe female threaded (socket) knobs are offered with a brass threaded insert. They have highly polished smooth surfaces and do not show a parting line. Very sturdy and attractive for any industrial or commercial application.

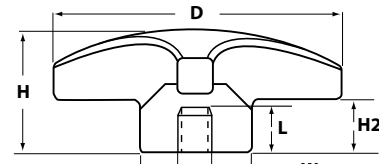

**4 LOBE KNOB WITH BRASS SOCKET - PHENOLIC**

P/N	Dia.	Height	Width	H2	Thread	Length
IL262-4F	1-1/4	13/16	9/16	3/8	1/4-20	1/2
IL262-5F	1-1/4	13/16	9/16	3/8	5/16-18	1/2
IL262-6F	1-1/4	13/16	9/16	3/8	3/8-16	1/2
IL263-4F	2	1-1/4	29/32	19/32	1/4-20	1/2
IL263-5F	2	1-1/4	29/32	19/32	5/16-18	1/2
IL263-6F	2	1-1/4	29/32	19/32	3/8-16	1/2

**4 Lobe Knob  
Steel Stud - Phenolic**

These best selling, economical phenolic 4 lobe threaded stud knobs are offered with a trivalent zinc plated steel stud. They have highly polished smooth surfaces and do not show a parting line. Very sturdy and attractive for any industrial or commercial application.

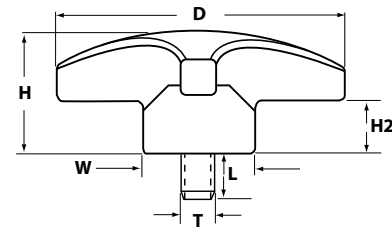

**4 LOBE KNOB WITH STEEL STUD - PHENOLIC**

P/N	Dia.	Height	Width	H2	Thread	Length
IL262-4MX1/2	1-1/4	13/16	9/16	3/8	1/4-20	1/2
IL262-4MX1	1-1/4	13/16	9/16	3/8	1/4-20	1
IL262-5MX1/2	1-1/4	13/16	9/16	3/8	5/16-18	1/2
IL262-5MX1	1-1/4	13/16	9/16	3/8	5/16-18	1
IL262-6MX3/4	1-1/4	13/16	9/16	3/8	3/8-16	3/4
IL262-6MX1	1-1/4	13/16	9/16	3/8	3/8-16	1
IL262-6MX1-1/2	1-1/4	13/16	9/16	3/8	3/8-16	1-1/2
IL263-4MX1	2	1-1/4	29/32	19/32	1/4-20	1
IL263-5MX1/2	2	1-1/4	29/32	19/32	5/16-18	1/2
IL263-5MX1	2	1-1/4	29/32	19/32	5/16-18	1
IL263-6MX3/4	2	1-1/4	29/32	19/32	3/8-16	3/4
IL263-6MX1	2	1-1/4	29/32	19/32	3/8-16	1
IL263-6MX1-1/2	2	1-1/4	29/32	19/32	3/8-16	1-1/2



**5 Lobe Knob  
Socket - Phenolic**

These best selling, economical high quality phenolic 5 lobe female threaded (socket) knobs are offered with a brass threaded insert. They have highly polished smooth surfaces and do not show a parting line. Very sturdy and attractive for any industrial or commercial application.

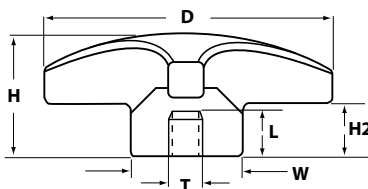

**5 Lobe Knob  
Steel Stud - Phenolic**

These high quality phenolic 5 lobe threaded stud knobs are offered with a trivalent zinc plated steel stud. They have highly polished smooth surfaces and do not show a parting line. Very sturdy and attractive for any industrial or commercial application.

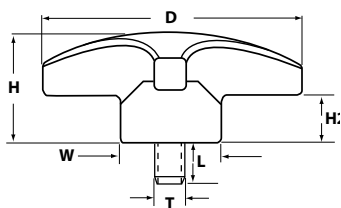

**5 LOBE KNOB WITH BRASS SOCKET - PHENOLIC**

P/N	Dia.	Height	Width	H2	Thread	Length
IL264-4F	1-1/2	1	13/16	15/32	1/4-20	5/8
IL264-5F	1-1/2	1	13/16	15/32	5/16-18	5/8
IL264-6F	1-1/2	1	13/16	15/32	3/8-16	5/8
IL265-5F	2	1-1/4	1	9/16	5/16-18	3/4
IL265-6F	2	1-1/4	1	9/16	3/8-16	3/4
IL265-7F	2	1-1/4	1	9/16	1/2-13	3/4
IL266-5F	2-1/2	1-1/2	1-7/32	5/8	5/16-18	7/8
IL266-6F	2-1/2	1-1/2	1-7/32	5/8	3/8-16	7/8
IL266-7F	2-1/2	1-1/2	1-7/32	5/8	1/2-13	7/8

**5 LOBE KNOB WITH STEEL STUD - PHENOLIC**

P/N	Dia.	Height	Width	H2	Thread	Length
IL264-4MX1/2	1-1/2	1	13/16	15/32	1/4-20	1/2
IL264-4MX1	1-1/2	1	13/16	15/32	1/4-20	1
IL264-5MX1/2	1-1/2	1	13/16	15/32	5/16-18	1/2
IL264-5MX1	1-1/2	1	13/16	15/32	5/16-18	1
IL264-5MX1-1/2	1-1/2	1	13/16	15/32	5/16-18	1-1/2
IL264-6MX3/4	1-1/2	1	13/16	15/32	3/8-16	3/4
IL264-6MX1-1/2	1-1/2	1	13/16	15/32	3/8-16	1-1/2
IL265-4MX3/4	2	1-1/4	1	9/16	1/4-20	3/4
IL265-4MX1-1/2	2	1-1/4	1	9/16	1/4-20	1-1/2
IL265-5MX3/4	2	1-1/4	1	9/16	5/16-18	3/4
IL265-5MX1	2	1-1/4	1	9/16	5/16-18	1
IL265-5MX1-1/2	2	1-1/4	1	9/16	5/16-18	1-1/2
IL265-6MX3/4	2	1-1/4	1	9/16	3/8-16	3/4
IL265-6MX1	2	1-1/4	1	9/16	3/8-16	1
IL265-6MX1-1/2	2	1-1/4	1	9/16	3/8-16	1-1/2
IL265-7MX1	2	1-1/4	1	9/16	1/2-13	1
IL266-5MX3/4	2-1/2	1-1/2	1-7/32	5/8	5/16-18	3/4
IL266-5MX1	2-1/2	1-1/2	1-7/32	5/8	5/16-18	1
IL266-5MX1-1/2	2-1/2	1-1/2	1-7/32	5/8	5/16-18	1-1/2
IL266-6MX3/4	2-1/2	1-1/2	1-7/32	5/8	3/8-16	3/4
IL266-6MX1	2-1/2	1-1/2	1-7/32	5/8	3/8-16	1
IL266-6MX1-1/2	2-1/2	1-1/2	1-7/32	5/8	3/8-16	1-1/2
IL266-7MX1	2-1/2	1-1/2	1-7/32	5/8	1/2-13	1
IL266-7MX2	2-1/2	1-1/2	1-7/32	5/8	1/2-13	2



**6 Lobe Knob  
Socket - Phenolic**

These best selling, economical phenolic 6 lobe female threaded (socket) knobs are offered with a brass threaded insert. They have highly polished smooth surfaces and do not show a parting line. Very sturdy and attractive for any industrial or commercial application.

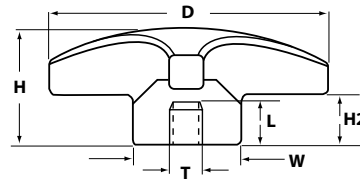

**6 LOBE KNOB WITH BRASS SOCKET - PHENOLIC**

P/N	Dia.	Height	Width	H2	Thread	Length
IL271-5F	2	1-3/16	1	5/8	5/16-18	11/16
IL271-6F	2	1-3/16	1	5/8	3/8-16	11/16
IL271-7F	2	1-3/16	1	5/8	1/2-13	11/16
IL271-8F	2	1-3/16	1	5/8	5/8-11	11/16
IL272-5F	2-1/2	1-3/8	1-3/32	3/4	5/16-18	7/8
IL272-6F	2-1/2	1-3/8	1-3/32	3/4	3/8-16	7/8
IL272-7F	2-1/2	1-3/8	1-3/32	3/4	1/2-13	7/8
IL272-8F	2-1/2	1-3/8	1-3/32	3/4	5/8-11	7/8
IL273-6F	3-1/8	2-3/16	1-1/4	1-1/4	3/8-16	1-1/4
IL273-7F	3-1/8	2-3/16	1-1/4	1-1/4	1/2-13	1-1/4
IL273-8F	3-1/8	2-3/16	1-1/4	1-1/4	5/8-11	1-1/4



**6 Lobe Knob  
Steel Stud - Phenolic**

These high quality phenolic 6 lobe threaded stud knobs are offered with a trivalent zinc plated steel stud. They have highly polished smooth surfaces and do not show a parting line. Very sturdy and attractive for any industrial or commercial application.

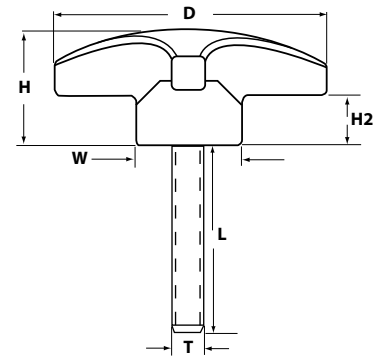

**6 LOBE KNOB WITH STEEL STUD - PHENOLIC**

P/N	Dia.	Height	Width	H2	Thread	Length
IL271-4MX1	2	1-3/16	1	5/8	1/4-20	1
IL271-5MX3/4	2	1-3/16	1	5/8	5/16-18	3/4
IL271-5MX1	2	1-3/16	1	5/8	5/16-18	1
IL271-5MX1-1/2	2	1-3/16	1	5/8	5/16-18	1-1/2
IL271-6MX3/4	2	1-3/16	1	5/8	3/8-16	3/4
IL271-6MX1	2	1-3/16	1	5/8	3/8-16	1
IL271-6MX1-1/2	2	1-3/16	1	5/8	3/8-16	1-1/2
IL271-6MX2	2	1-3/16	1	5/8	3/8-16	2
IL271-7MX1	2	1-3/16	1	5/8	1/2-13	1
IL271-7MX2	2	1-3/16	1	5/8	1/2-13	2
IL271-8MX1	2	1-3/16	1	5/8	5/8-11	1
IL271-8MX2	2	1-3/16	1	5/8	5/8-11	2
IL272-5MX3/4	2-1/2	1-3/8	1-3/32	3/4	5/16-18	3/4
IL272-5MX1	2-1/2	1-3/8	1-3/32	3/4	5/16-18	1
IL272-5MX1-1/2	2-1/2	1-3/8	1-3/32	3/4	5/16-18	1-1/2
IL272-6MX1	2-1/2	1-3/8	1-3/32	3/4	3/8-16	1
IL272-6MX1-1/2	2-1/2	1-3/8	1-3/32	3/4	3/8-16	1-1/2
IL272-6MX2	2-1/2	1-3/8	1-3/32	3/4	3/8-16	2
IL272-7MX1	2-1/2	1-3/8	1-3/32	3/4	1/2-13	1
IL272-7MX2	2-1/2	1-3/8	1-3/32	3/4	1/2-13	2
IL272-8MX1	2-1/2	1-3/8	1-3/32	3/4	5/8-11	1
IL272-8MX2	2-1/2	1-3/8	1-3/32	3/4	5/8-11	2
IL273-5MX1	3-1/8	2-3/16	1-1/4	1-1/4	5/16-18	1
IL273-5MX1-1/2	3-1/8	2-3/16	1-1/4	1-1/4	5/16-18	1-1/2
IL273-6MX1	3-1/8	2-3/16	1-1/4	1-1/4	3/8-16	1
IL273-6MX1-1/2	3-1/8	2-3/16	1-1/4	1-1/4	3/8-16	1-1/2
IL273-6MX2	3-1/8	2-3/16	1-1/4	1-1/4	3/8-16	2
IL273-7MX1	3-1/8	2-3/16	1-1/4	1-1/4	1/2-13	1
IL273-7MX2	3-1/8	2-3/16	1-1/4	1-1/4	1/2-13	2
IL273-8MX1	3-1/8	2-3/16	1-1/4	1-1/4	5/8-11	1
IL273-8MX2	3-1/8	2-3/16	1-1/4	1-1/4	5/8-11	2



**3 Lobe Knob  
Thru Hole - Phenolic**

These best selling, economical phenolic 3 lobe thru-hole threaded knobs are offered with a brass threaded insert. They have highly polished smooth surfaces and do not show a parting line. Very sturdy and attractive for any industrial or commercial application.

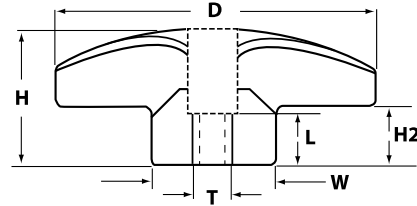

**3 LOBE THRU HOLE KNOB - PHENOLIC**

P/N	Dia.	Height	Width	H2	Thread	Length
IL261-4T	1-1/2	1	7/8	1/2	1/4-20	3/4
IL261-5T	1-1/2	1	7/8	1/2	5/16-18	3/4
IL261-6T	1-1/2	1	7/8	1/2	3/8-16	3/4

**7 Lobe Knob  
Thru Hole - Phenolic**

These best selling, economical phenolic 7 lobe thru-hole threaded knobs are offered with a brass threaded insert. They have highly polished smooth surfaces and do not show a parting line. Very sturdy and attractive for any industrial or commercial application.

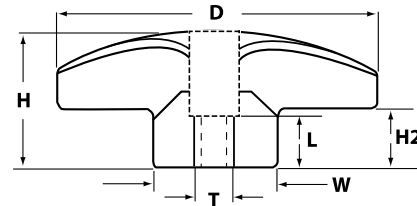

**7 LOBE KNOB WITH BRASS THRU HOLE - PHENOLIC**

P/N	Dia.	Height	Width	H2	Thread	Length
IL267-4T	1-1/2	1-3/32	7/8	9/16	1/4-20	3/4
IL267-5T	1-1/2	1-3/32	7/8	9/16	5/16-18	3/4
IL267-6T	1-1/2	1-3/32	7/8	9/16	3/8-16	3/4
IL267-7T	1-1/2	1-3/32	7/8	9/16	1/2-13	3/4
IL268-4T	2	1-1/4	1-1/8	5/8	1/4-20	1
IL268-5T	2	1-1/4	1-1/8	5/8	5/16-18	1
IL268-6T	2	1-1/4	1-1/8	5/8	3/8-16	1
IL268-7T	2	1-1/4	1-1/8	5/8	1/2-13	1
IL269-5T	2-1/2	1-1/2	1-1/4	11/16	5/16-18	1-1/4
IL269-6T	2-1/2	1-1/2	1-1/4	11/16	3/8-16	1-1/4
IL269-7T	2-1/2	1-1/2	1-1/4	11/16	1/2-13	1-1/4
IL269-8T	2-1/2	1-1/2	1-1/4	11/16	5/8-11	1-1/4
IL270-6T	3-1/8	2	1-3/8	1	3/8-16	1-1/4
IL270-7T	3-1/8	2	1-3/8	1	1/2-13	1-1/4
IL270-8T	3-1/8	2	1-3/8	1	5/8-11	1-1/4