

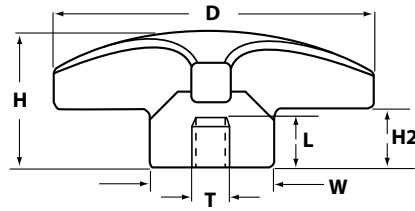

KNOBS
5 LOBE KNOBS

5 Lobe Knobs

Phenolic 5-lobe knobs are offered with a brass threaded insert, a zinc-plated steel stud or a stainless steel stud.



PHENOLIC. 5 LOBE WITH ZINC-PLATED STEEL THREADED INSERT

P/N	DIA.	Height	Width	H2	Thread	Length
IL450-4X50	1-1/4	1	7/8	3/4	1/4-20	1/2
IL450-5X50	1-1/4	1	7/8	3/4	5/16-18	1/2
IL451-4X50	1-3/4	1	7/8	3/4	1/4-20	1/2
IL451-5X50	1-3/4	1	7/8	3/4	5/16-18	1/2

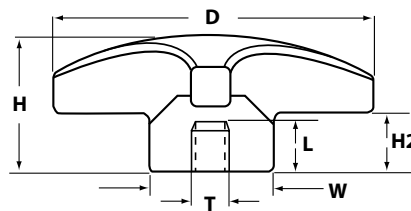

PHENOLIC 5 LOBE KNOB WITH BRASS THREADED INSERT

P/N	DIA.	Height	Width	H2	Thread	Length
IL452-4X38	2-1/4	3/4	7/8	1/4	1/4-20	3/8
IL452-5X50	2-1/4	3/4	7/8	1/4	5/16-18	1/2
IL452-6X50	2-1/4	3/4	7/8	1/4	3/8-16	1/2

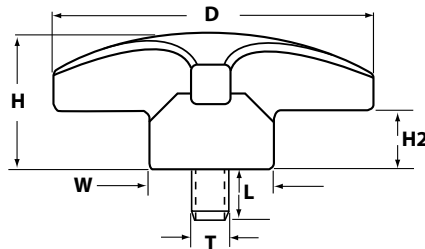

POLYPROPYLENE 5 LOBE KNOB WITH ZINC-PLATED STEEL STUD

P/N	DIA.	Height	Width	H2	Thread	Length
IL453-4X1	1-3/8	1-1/4	7/8	3/4	1/4-20	1
IL453-5X150	1-3/8	1-1/4	7/8	3/4	5/16-18	1-1/2
IL453-4X150	1-3/4	1-1/4	7/8	3/4	1/4-20	1-1/2
IL453-5X2	1-3/4	1-1/4	7/8	3/4	5/16-18	2
IL454-5X75	2-1/4	3/4	7/8	1/4	5/16-18	3/4
IL454-6X1	2-1/4	3/4	7/8	1/4	3/8-16	1



5 Lobe Knobs

Phenolic 5 lobe knobs are offered with a brass threaded insert, a zinc-plated steel stud or a stainless steel stud.

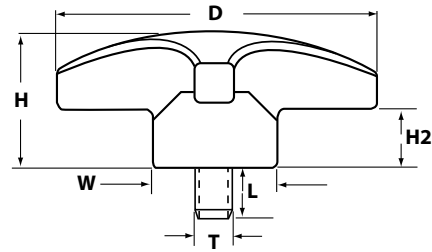

THERMOPLASTIC 5 LOBE KNOB WITH ZINC PLATED STEEL STUD

P/N	DIA.	Height	Width	H2	Thread	Length
IL453A-3FX50	1	3/4	1/2		10-32	1/2
IL453A-3FX75	1	3/4	1/2		10-32	3/4
IL453A-4X50	1-1/4	7/8	5/8		1/4-20	1/2
IL453A-4X75	1-1/4	7/8	5/8		1/4-20	3/4
IL453A-4X1	1-1/4	7/8	5/8		1/4-20	1
IL453B-4X50	1-9/16	1	11/16		1/4-20	1/2
IL453B-4X1	1-9/16	1	11/16		1/4-20	1
IL453B-5X75	1-9/16	1	11/16		5/16-18	3/4
IL453B-5X1	1-9/16	1	11/16		5/16-18	1
IL453C-5X1	2	1-1/4	3/4		5/16-18	1
IL453C-5X150	2	1-1/4	3/4		5/16-18	1-1/2
IL453C-6X1	2	1-1/4	3/4		3/8-16	1
IL453C-6X150	2	1-1/4	3/4		3/8-16	1-1/2
IL454A-6X125	2-1/2	1-1/2	7/8		3/8-16	1-1/4
IL454A-6X2	2-1/2	1-1/2	7/8		3/8-16	2
IL454A-7X150	2-1/2	1-1/2	7/8		1/2-13	1-1/2

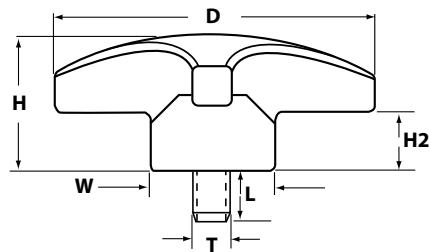

PHENOLIC 5 LOBE KNOB WITH STAINLESS STEEL STUD

P/N	DIA.	Height	Width	H2	Thread	Length
IL455-4X50-SS	1-1/4	13/16	7/8	3/8	1/4-20	1/2
IL455-5X50-SS	1-1/4	13/16	7/8	3/8	5/16-18	1/2
IL455-5X1-SS	1-1/4	13/16	7/8	3/8	5/16-18	1
IL456-4X50-SS	1-3/4	7/8	1-3/16	1/4	1/4-20	1/2
IL456-5X50-SS	1-3/4	7/8	1-3/16	1/4	5/16-18	1/2
IL456-5X1-SS	1-3/4	7/8	1-3/16	1/4	5/16-18	1



5 & 6 Lobe Knobs

Phenolic 5 lobe knob with thru hole and steel insert.

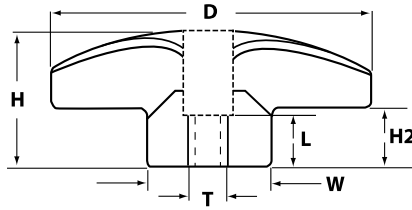

PHENOLIC 5 LOBE KNOB THRU HOLE WITH STEEL INSERT

P/N	DIA.	Height	Width	H2	Thread	Length
IL457-4X38	2-1/4	23/32	27/32	1/4	1/4-20	3/8
IL457-5X38	2-1/4	23/32	27/32	1/4	5/16-18	3/8
IL457-6X38	2-1/4	23/32	27/32	1/4	3/8-16	3/8

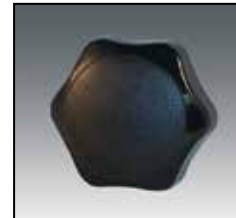
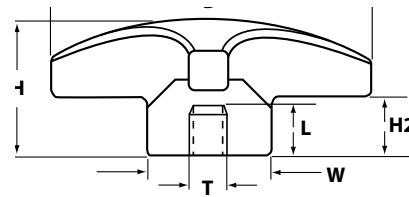

Thermoplastic 6 lobe knob with brass or stainless steel threaded insert shown to right.

THERMOPLASTIC 6 LOBE KNOB WITH BRASS OR S.S. THREADED INSERT

P/N	P/N	DIA.	Height	Width	H2	Thread	Length
IL460-3FX25	IL460-3FX25-SS	1-1/4	3/4	5/8	3/8	10-24	1/4
IL460-4X38	IL460-4X38-SS	1-1/4	3/4	5/8	3/8	1/4-20	3/8
IL460-5X50	IL460-5X50-SS	1-1/4	3/4	5/8	1/2	5/16-18	1/2
IL461-4X38	IL461-4X38-SS	1-1/2	1	11/16	1/2	1/4-20	3/8
IL461-5X50	IL461-5X50-SS	1-1/2	1	11/16	1/2	5/16-18	1/2
IL461-6X56	IL461-6X56-SS	1-1/2	1	11/16	1/2	3/8-16	9/16
IL462-5X50	IL462-5X50-SS	2	1-1/8	3/4	9/16	5/16-18	1/2
IL462-6X56	IL462-6X56-SS	2	1-1/8	3/4	9/16	3/8-16	3/8
IL462-7X75	IL462-7X75-SS	2	1-1/8	3/4	9/16	1/2-13	3/4
IL463-5X50	IL463-5X50-SS	2-3/8	1-1/4	1	3/4	5/16-18	1/2
IL463-6X56	IL463-6X56-SS	2-3/8	1-1/4	1	3/4	3/8-16	9/16
IL463-7X75	IL463-7X75-SS	2-3/8	1-1/4	1	3/4	1/2-13	3/4

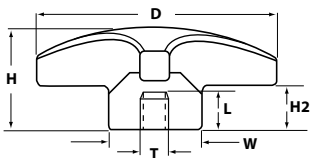

Thermoplastic 6 lobe knob with thru hole and brass insert.



THERMOPLASTIC 6 LOBE KNOB WITH THRU HOLE AND BRASS INSERT

P/N	DIA.	Height	Width	H2	Thread	Length
IL461-4X38-TH	1-1/2	1/2	7/8	1/8	1/4-20	3/8
IL461-5X38-TH	1-1/2	1/2	7/8	1/8	5/16-18	3/8
IL461-6X38-TH	1-1/2	1/2	7/8	1/8	3/8-16	3/8
IL461-7X38-TH	1-1/2	1/2	7/8	1/8	1/2-13	3/8
IL462-4X38-TH	2	9/16	1	1/8	1/4-20	3/8
IL462-5X38-TH	2	9/16	1	1/8	5/16-18	3/8
IL462-6X38-TH	2	9/16	1	1/8	3/8-16	3/8
IL462-7X38-TH	2	9/16	1	1/8	1/2-13	3/8



6 & 7 Lobe Knobs

Phenolic 6-lobe knobs are offered with a brass threaded insert, a zinc-plated steel stud or a stainless steel stud.



PHENOLIC 6 LOBE KNOB WITH ZINC PLATED STEEL STUD

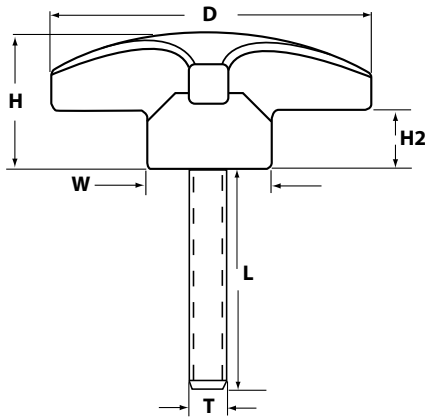

P/N	DIA.	Height	Width	H2	Thread	Length
IL464-4X75	7/8	3/4	1/2	3/8	1/4-20	3/4
IL465-4X50	1-1/4	7/8	3/4	3/8	1/4-20	1/2
IL465-4X75	1-1/4	7/8	3/4	3/8	1/4-20	3/4
IL465-4X1	1-1/4	7/8	3/4	3/8	1/4-20	1
IL465-5X75	1-1/4	7/8	3/4	3/8	5/16-18	3/4
IL465-5X1	1-1/4	7/8	3/4	3/8	5/16-18	1
IL465-5X150	1-1/4	7/8	3/4	3/8	5/16-18	1-1/2
IL466-5X125	1-3/4	1	7/8	3/8	5/16-18	1-1/4
IL466-6X1	1-3/4	1	7/8	3/8	3/8-16	1
IL466-6X125	1-3/4	1	7/8	3/8	3/8-16	1-1/4
IL466-6X175	1-3/4	1	7/8	3/8	3/8-16	1-3/4
IL467-6X150	2-1/4	1-1/4	1	7/16	3/8-16	1-1/2
IL467-7X150	2-1/4	1-1/4	1	7/16	1/2-13	1-1/2
IL467-7X2	2-1/4	1-1/4	1	7/16	1/2-13	2
IL468-7X150	2-5/8	1-5/8	1-1/8	5/8	1/2-13	1-1/2
IL468-7X2	2-5/8	1-5/8	1-1/8	5/8	1/2-13	2



Phenolic 7-lobe knobs are offered with a brass threaded insert, a zinc-plated steel stud or a stainless steel stud.

THERMOPLASTIC 7 LOBE KNOB WITH BRASS THREADED INSERT

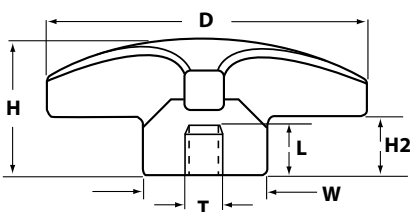

P/N	DIA.	Height	Width	H2	Thread	Length
IL470-2X38	1	5/8	1/2	5/16	8-32	3/8
IL470-3FX38	1	5/8	1/2	5/16	10-32	3/8
IL470-4X38	1	5/8	1/2	5/16	1/4-20	3/8
IL471-3FX38	1-1/4	3/4	9/16	3/8	10-32	3/8
IL471-4X38	1-1/4	3/4	9/16	3/8	1/4-20	3/8
IL472-5X56	1-9/16	1	11/16	1/2	5/16-18	9/16
IL472-6X56	1-9/16	1	11/16	1/2	3/8-16	9/16
IL473-5X56	2	1-1/4	7/8	11/16	5/16-18	9/16
IL473-6X56	2	1-1/4	7/8	11/16	3/8-16	9/16
IL473-7X69	2	1-1/4	7/8	11/16	5/16-18	11/16
IL474-6X56	2-1/2	1-1/2	1	13/16	3/8-16	9/16
IL474-7X69	2-1/2	1-1/2	1	13/16	1/2-13	11/16
IL474-8X69	2-1/2	1-1/2	1	13/16	5/8-11	11/16